

# MCU

STM32F103C8T6

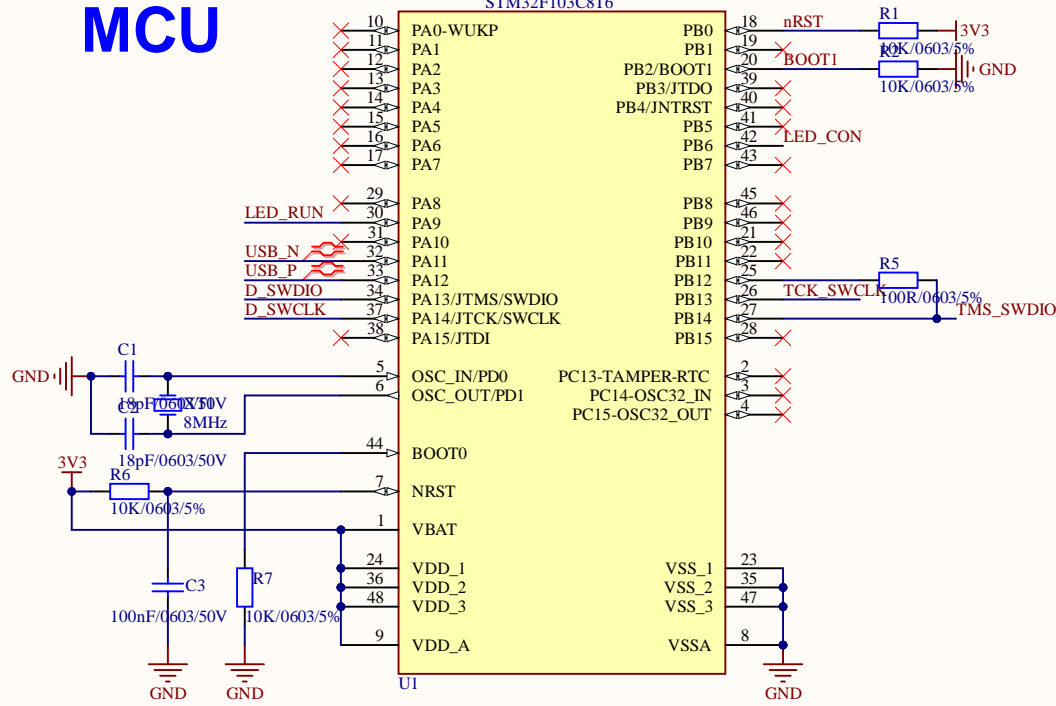

# Program

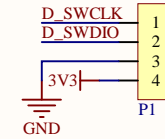

# State

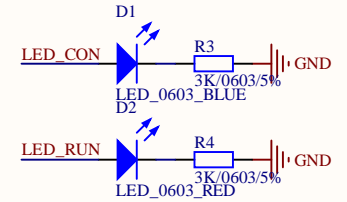

# Debug

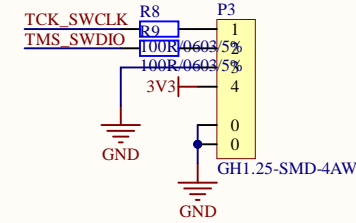

# Fix

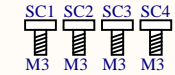

# USB

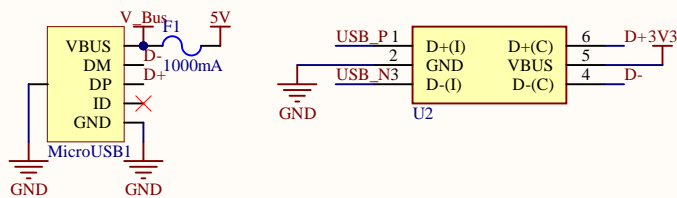

# Power

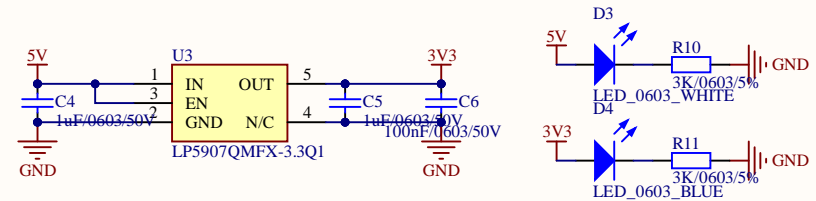

Title		
HWSD-Toolkit Series-DAPLink		
Size	Number	Revision
A4		V3.0
Date:	10/27/2021	Sheet of
File:	C:\Users\...\HWSD-DAPLink SCH.SchDoc	Drawn By: ASR-Crash